

VG.B42 bellows suction cups in EPDM-HNBR with silicone foam ring

- Ideal to handle uneven and porous surfaces
- High adaptability on rough wood panels, corrugated sheet metal and non-slip sheet metal
- Ring in mark-free silicone foam

Application example

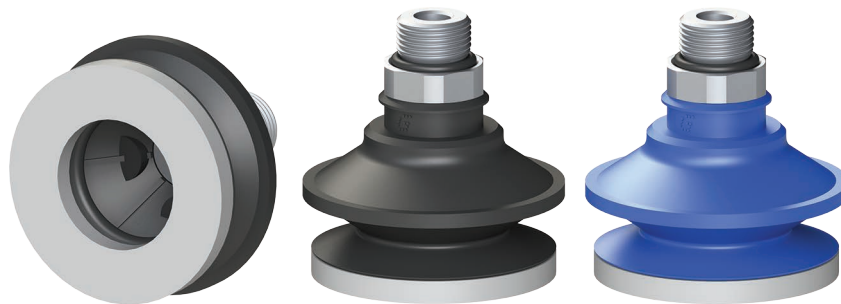

Technical features

Material	Colour	Hardness	Temperature range
EPDM	Black	50 Shore	-40 ÷ +100 °C
HNBR	Blue	60 Shore	-25 ÷ +150 °C

Identification codes

Drawing	Alphanumeric code	Suction cups with fitting	Order code
A	VG.B42E.50.G18F.E12.SFO	VG.B42 suction cup, EPDM, 50 Shore, G1/8" female, 12 mm hex with silicone foam ring	0321624
B	VG.B42E.50.G18M.E12.SFO	VG.B42 suction cup, EPDM, 50 Shore, G1/8" male, 12 mm hex with silicone foam ring	0321626
C	VG.B42E.50.G18F.E16.SFO	VG.B42 suction cup, EPDM, 50 Shore, G1/8" female, 16 mm hex with silicone foam ring	0321627
D	VG.B42E.50.G18M.E16.SFO	VG.B42 suction cup, EPDM, 50 Shore, G1/8" male, 16 mm hex with silicone foam ring	0321628
E	VG.B42E.50.G14F.E16.SFO	VG.B42 suction cup, EPDM, 50 Shore, G1/4" female, 16 mm hex with silicone foam ring	0321629
F	VG.B42E.50.G14M.E17.SFO	VG.B42 suction cup, EPDM, 50 Shore, G1/4" male, 17 mm hex with silicone foam ring	0321630
A	VG.B42H.60.G18F.E12.SFO	VG.B42 suction cup, HNBR, 60 Shore, G1/8" female, 12 mm hex with silicone foam ring	0321631
B	VG.B42H.60.G18M.E12.SFO	VG.B42 suction cup, HNBR, 60 Shore, G1/8" male, 12 mm hex with silicone foam ring	0321633
C	VG.B42H.60.G18F.E16.SFO	VG.B42 suction cup, HNBR, 60 Shore, G1/8" female, 16 mm hex with silicone foam ring	0321635
D	VG.B42H.60.G18M.E16.SFO	VG.B42 suction cup, HNBR, 60 Shore, G1/8" male, 16 mm hex with silicone foam ring	0321636
E	VG.B42H.60.G14F.E16.SFO	VG.B42 suction cup, HNBR, 60 Shore, G1/4" female, 16 mm hex with silicone foam ring	0321637
F	VG.B42H.60.G14M.E17.SFO	VG.B42 suction cup, HNBR, 60 Shore, G1/4" male, 17 mm hex with silicone foam ring	0321638

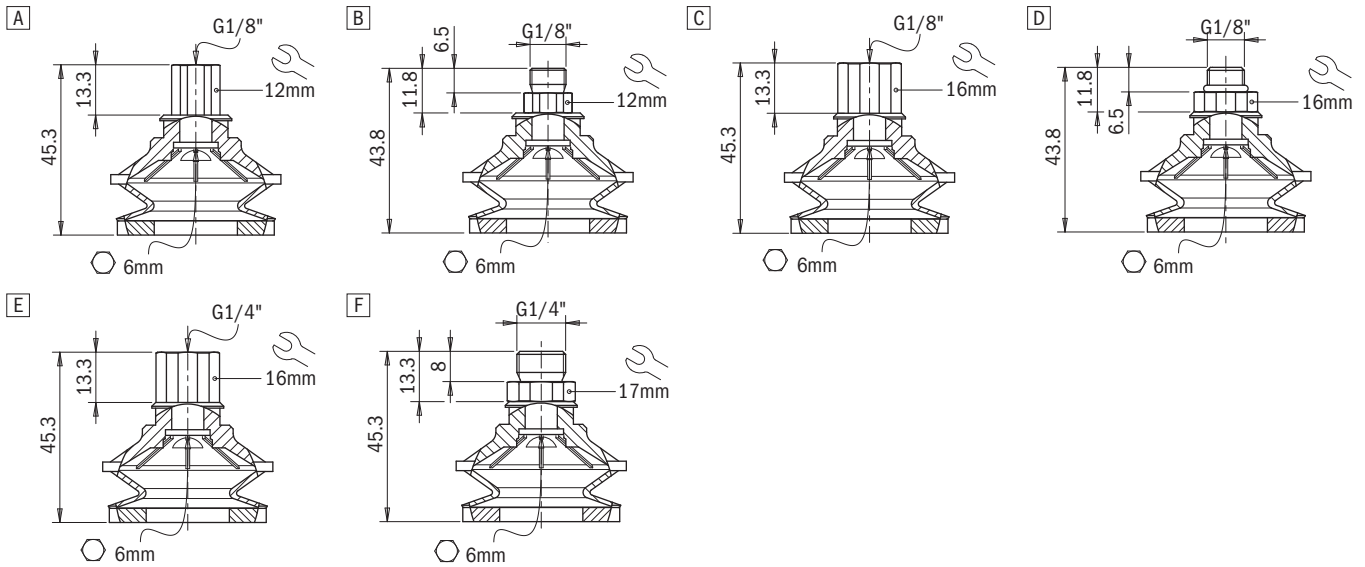
Identification codes

Drawing	Alphanumeric code	Suction cups	Order code
A	VG.B42E.50.SFO	VG.B42 suction cup in EPDM, 50 Shore, with silicone foam ring	0321625
A	VG.B42H.60.SFO	VG.B42 suction cup in HNBR, 60 Shore, with silicone foam ring	0321632

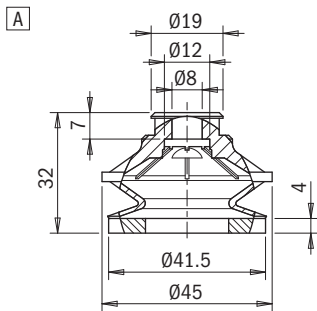
Identification codes

Drawing	Alphanumeric code	Fittings	Order code
A	FT.G18F.E12	G1/8" female fitting, 12 mm hex	2321422
B	FT.G18M.E12	G1/8" male fitting, 12 mm hex	2321424
C	FT.G18F.E16	G1/8" female fitting, 16 mm hex	2321426
D	FT.G18M.E16	G1/8" male fitting, 16 mm hex	2321428
E	FT.G14F.E16	G1/4" female fitting, 16 mm hex	2321430
F	FT.G14M.E17	G1/4" male fitting, 17 mm hex	2321432

